

### Features

- Excellent thermal stability
- Common source configuration Push-pull
- $P_{OUT} = 150W$  with 13dB gain @ 860MHz / 32V
- BeO free package
- Internal input matching
- In compliance with the 2002/95/EC european directive

### Description

The SD56150 is a common source N-channel enhancement-mode lateral Field-Effect RF power transistor designed for broadband commercial and industrial applications at frequencies up to 1.0 GHz. The SD56150 is designed for high gain and broadband performance operating in common source mode at 32 V. Its internal matching makes it ideal for TV broadcast applications requiring high linearity.

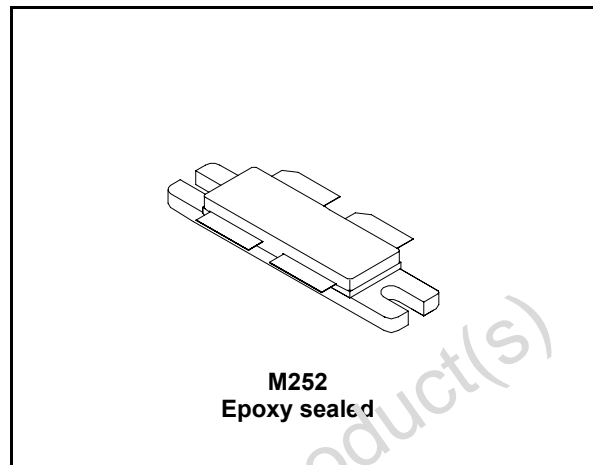

**Figure 1. Pin connection**

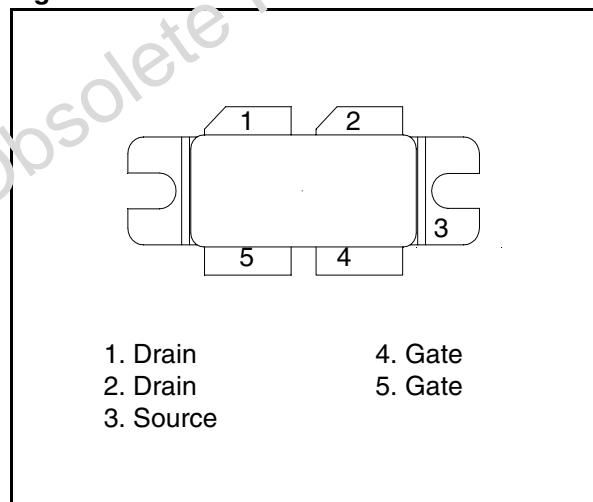

**Table 1. Device summary**

Order code	Package	Branding
SD56150	M252	SD56150

# Contents

<b>1</b>	<b>Electrical data</b> .....	<b>3</b>
1.1	Maximum ratings .....	3
1.2	Thermal data .....	3
<b>2</b>	<b>Electrical characteristics</b> .....	<b>4</b>
2.1	Static .....	4
2.2	Dynamic .....	4
<b>3</b>	<b>Impedance</b> .....	<b>5</b>
<b>4</b>	<b>Typical performance</b> .....	<b>6</b>
<b>5</b>	<b>Package mechanical data</b> .....	<b>12</b>
<b>6</b>	<b>Revision history</b> .....	<b>13</b>

Obsolete Product(s) - Obsolete Product(s)

# 1 Electrical data

## 1.1 Maximum ratings

**Table 2. Absolute maximum ratings ( $T_{CASE} = 25^{\circ}C$ )**

Symbol	Parameter	Value	Unit
$V_{(BR)DSS}$	Drain-Source Voltage	65	V
$V_{GS}$	Gate-Source Voltage	$\pm 20$	V
$I_D$	Drain Current	17	A
$P_{DISS}$	Power Dissipation (@ $T_c = 70^{\circ}C$ )	236	W
$T_j$	Max. Operating Junction Temperature	200	$^{\circ}C$
$T_{STG}$	Storage Temperature	-65 to +150	$^{\circ}C$

## 1.2 Thermal data

**Table 3. Thermal data**

Symbol	Parameter	Value	Unit
$R_{thJC}$	Junction - case thermal resistance	0.55	$^{\circ}C/W$

## 2 Electrical characteristics

$$T_{CASE} = +25\text{ }^{\circ}\text{C}$$

### 2.1 Static

**Table 4. Static (per section)**

Symbol	Test conditions		Min	Typ	Max	Unit
$V_{(BR)DSS}$	$V_{GS} = 0\text{ V}$	$I_{DS} = 10\text{ mA}$	65			V
$I_{DSS}$	$V_{GS} = 0\text{ V}$	$V_{DS} = 28\text{ V}$			1	$\mu\text{A}$
$I_{GSS}$	$V_{GS} = 20\text{ V}$	$V_{DS} = 0\text{ V}$			1	$\mu\text{A}$
$V_{GS(Q)}$	$V_{DS} = 28\text{ V}$	$I_D = 100\text{ mA}$	2.0		5.0	V
$V_{DS(ON)}$	$V_{GS} = 10\text{ V}$	$I_D = 3\text{ A}$		0.5	0.8	V
$G_{FS}$	$V_{DS} = 10\text{ V}$	$I_D = 3\text{ A}$	2.5		4	mho
$C_{ISS}^{(1)}$	$V_{GS} = 0\text{ V}$	$V_{DS} = 28\text{ V}$		255		pF
$C_{OSS}$	$V_{GS} = 0\text{ V}$	$V_{DS} = 28\text{ V}$		50		pF
$C_{RSS}$	$V_{GS} = 0\text{ V}$	$V_{DS} = 28\text{ V}$		2.9		pF

1. Includes Internal Input Moscap.

### 2.2 Dynamic

**Table 5. Dynamic**

Symbol	Test conditions		Min	Typ	Max	Unit
$P_{OUT}$	$V_{DD} = 32\text{ V}$	$I_{DQ} = 500\text{ mA}$ $f = 860\text{MHz}$	150			W
$G_{PS}$	$V_{DD} = 32\text{ V}$	$I_{DQ} = 500\text{ mA}$ $P_{OUT} = 150\text{ W}, f = 860\text{MHz}$	13	16.5		dB
$h_D$	$V_{DD} = 32\text{ V}$	$I_{DQ} = 500\text{ mA}$ $P_{OUT} = 150\text{ W}, f = 860\text{MHz}$	50	60		%
Load mismatch	$V_{DD} = 32\text{ V}$	$I_{DQ} = 500\text{ mA}$ $P_{OUT} = 150\text{ W}, f = 860\text{MHz}$ All phase angles	10:1			VSWR

### 3 Impedance

Figure 2. Current conventions

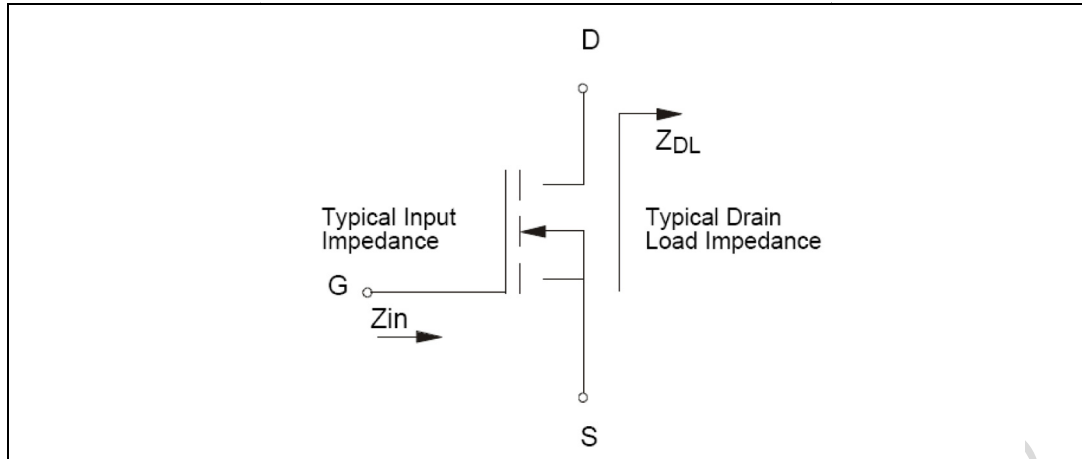

Table 6. Impedance data

Freq. (MHz)	$Z_{IN}$ ( $\Omega$ )	$Z_{DL}$ ( $\Omega$ )
860 MHz	$4.7 - j 5.5$	$3.6 + j 6.5$
880 MHz	$4.3 - j 6.9$	$3.9 + j 7.4$
900 MHz	$4.5 - j 8.8$	$4.4 + j 7.8$

Note: Measured drain to drain and gate to gate respectively.

# 4 Typical performance

Figure 3. Capacitance vs drain voltage

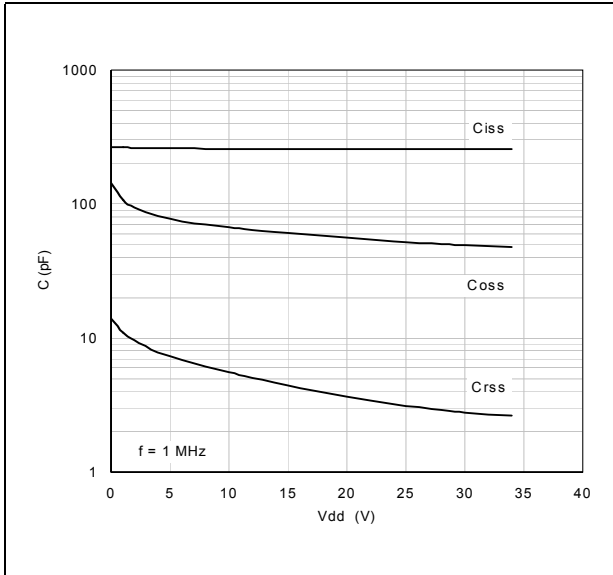

Figure 4. Gate-source voltage vs case temperature

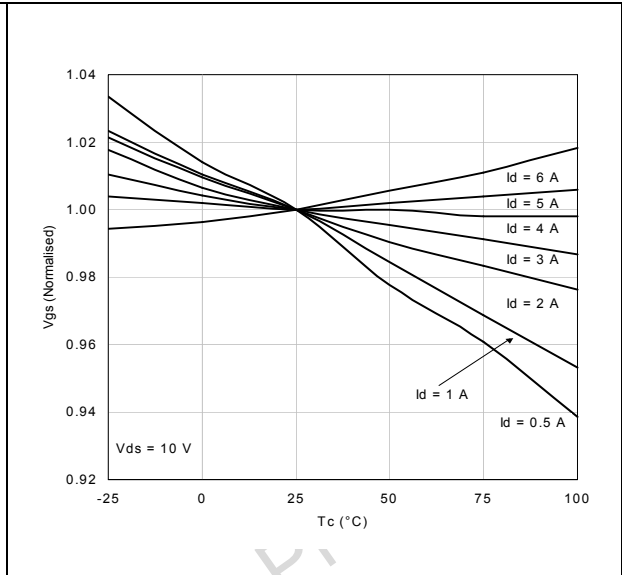

Figure 5. Drain current vs gate voltage

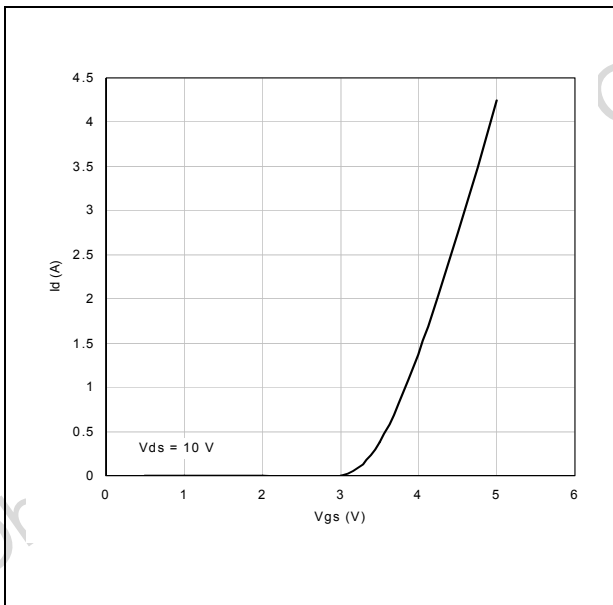

Figure 6. Output power vs input power

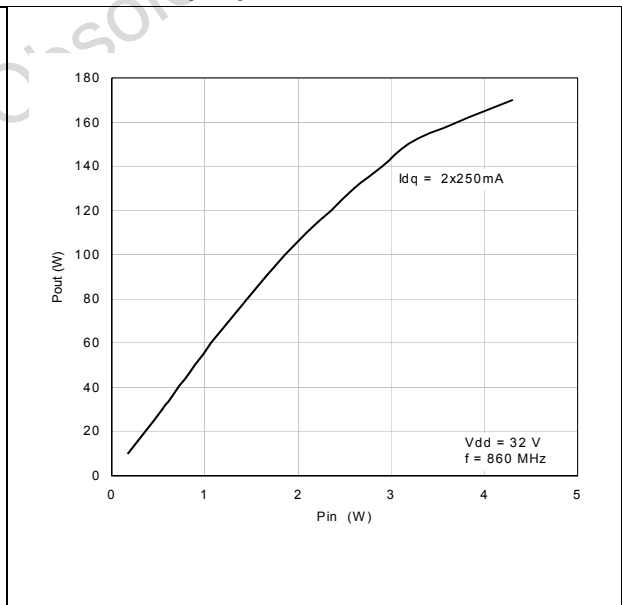

Figure 7. Power gain vs output power

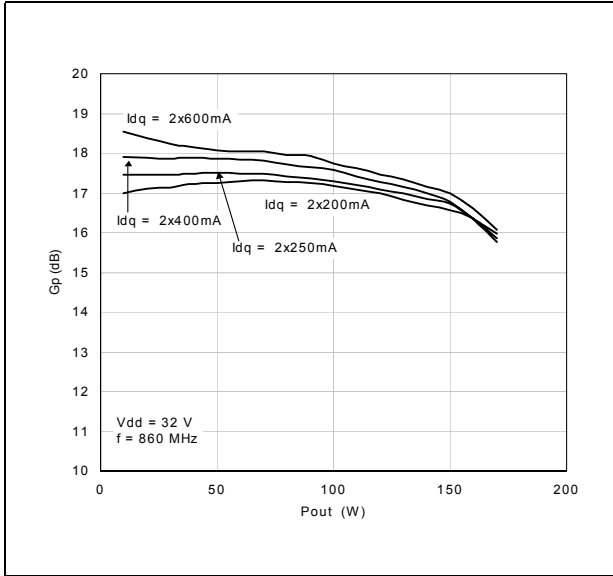

Figure 8. Efficiency vs output power

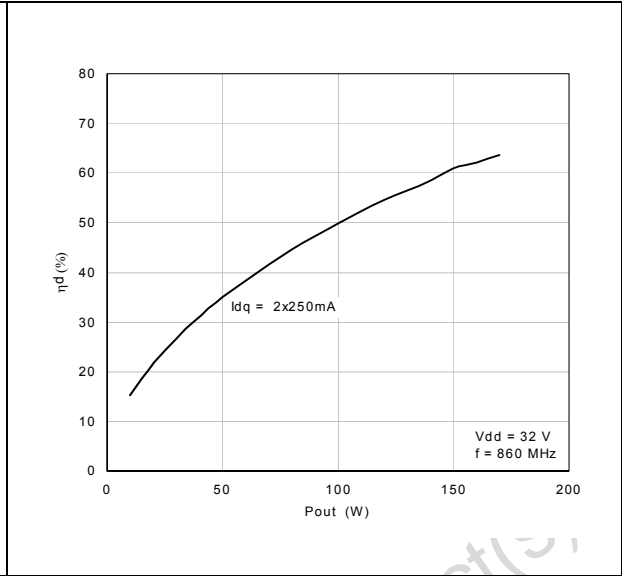
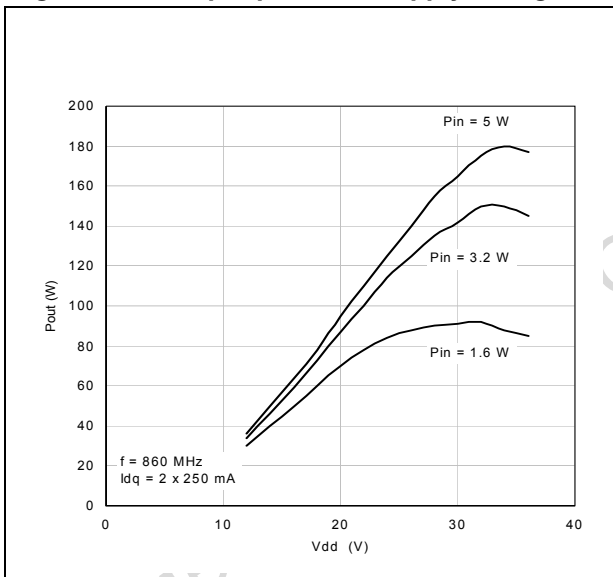

Figure 9. Output power vs supply voltage



Obsolete Product

Figure 10. Efficiency vs supply voltage

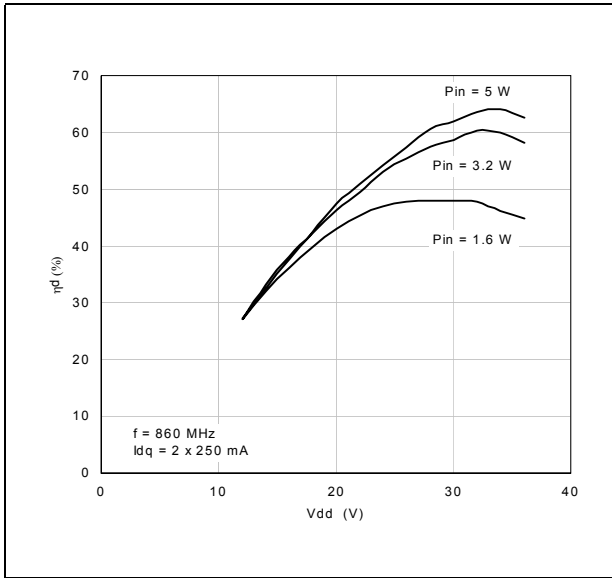
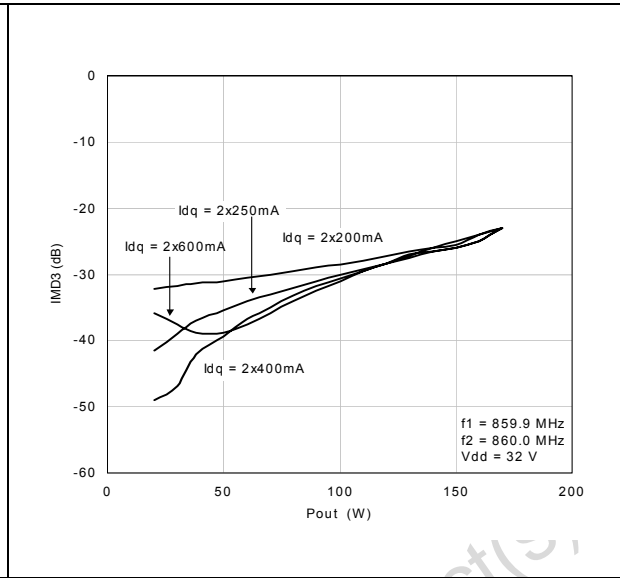

Figure 11. Intermodulation distortion vs output power



Obsolete Product(s) - Obsolete Product(s)



Figure 12. Test circuit schematic

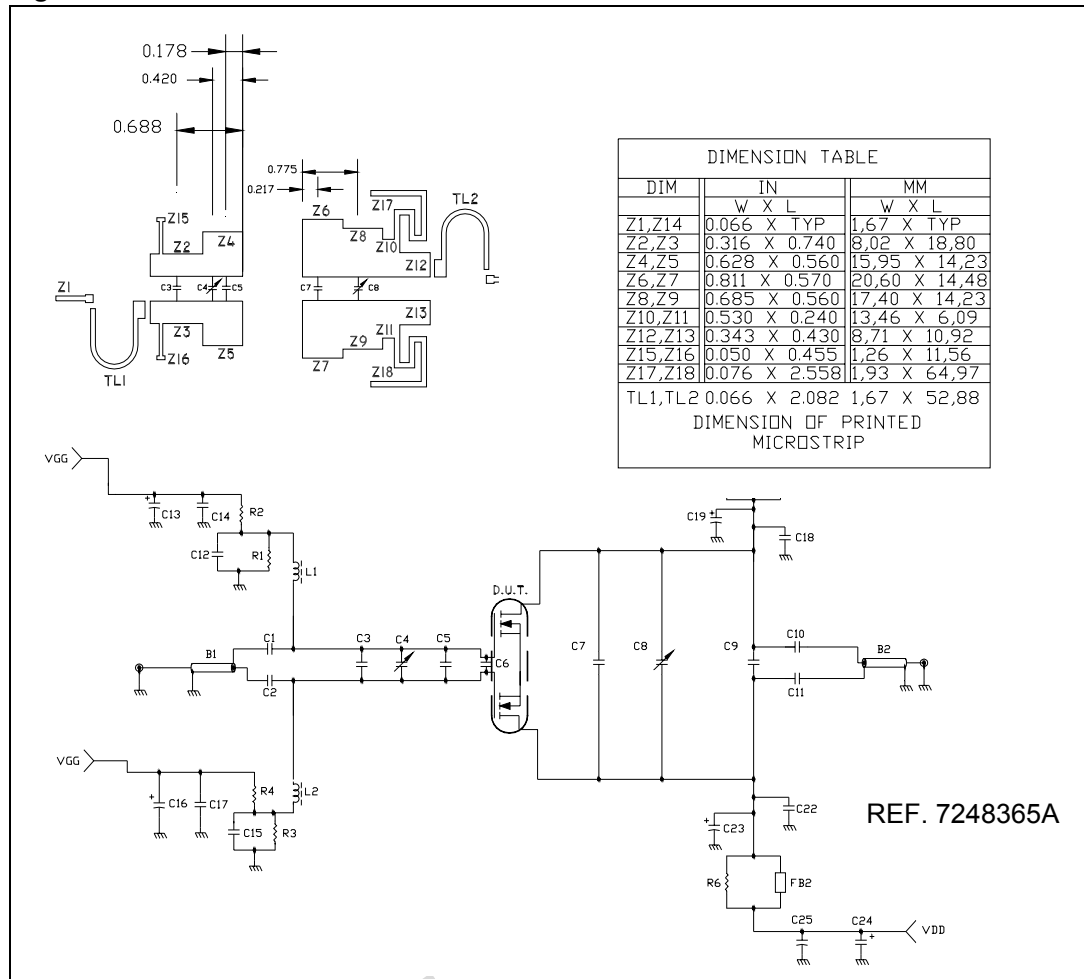

- 1 Gap between ground & transmission line = 0.056 [1.42] +0.002 [0.05] -0.000 [0.00] Typ.
- 2 C3 and C4 adjacent to each other

Obsolete Product

Table 7. Test circuit component part list

Component	Description
C1,C2, C10, C11	51 pF ATC 100B SURFACE MOUNT CERAMIC CHIP CAPACITOR
C3	9.1 pF ATC 100B SURFACE MOUNT CERAMIC CHIP CAPACITOR
C4, C8	0.6 - 4.5 pF GIGATRIM VARIABLE CAPACITOR
C5	10 pF ATC 100B SURFACE MOUNT CERAMIC CHIP CAPACITOR
C6	4.7 pF ATC 100A SURFACE MOUNT CERAMIC CHIP CAPACITOR
C7	13 pF ATC 100B SURFACE MOUNT CERAMIC CHIP CAPACITOR
C9	6.2 pF ATC 100B SURFACE MOUNT CERAMIC CHIP CAPACITOR
C12, C15, C18, C22	91 pF ATC 100B SURFACE MOUNT CERAMIC CHIP CAPACITOR
C13, C16, C20, C24	10 $\mu$ F 50V ALUMINUM ELECTROLYTIC RADIAL LEAD CAPACITOR
C14, C17, C21, C25	0.1 $\mu$ F 500V SURFACE MOUNT CERAMIC CHIP CAPACITOR
C19, C23	100 $\mu$ F 63V ALUMINUM ELECTROLYTIC RADIAL LEAD CAPACITOR
R1, R2, R3, R4	200 OHM 1/4 W SURFACE MOUNT CHIP RESISTOR
R5, R6	1.8 OHM 1/4 W SURFACE MOUNT CHIP RESISTOR
L1, L2	CHIP INDUCTOR 10 nH SURFACE MOUNT COIL
FB1, FB2	SURFACE MOUNT EMI SHIELD BEAD
B2, B1	BALUN, 25 OHM, SEMI-RIDGE OD 0.141 2.365 LG COAXIAL CABLE OR EQUIVALENT
PCB	WOVEN GLASS REINFORCED / CERAMIC FILLED 0.030" THK $\epsilon_r = 3.48$ , 2 Oz ED CU BOTH SIDES

Figure 13. Test fixture

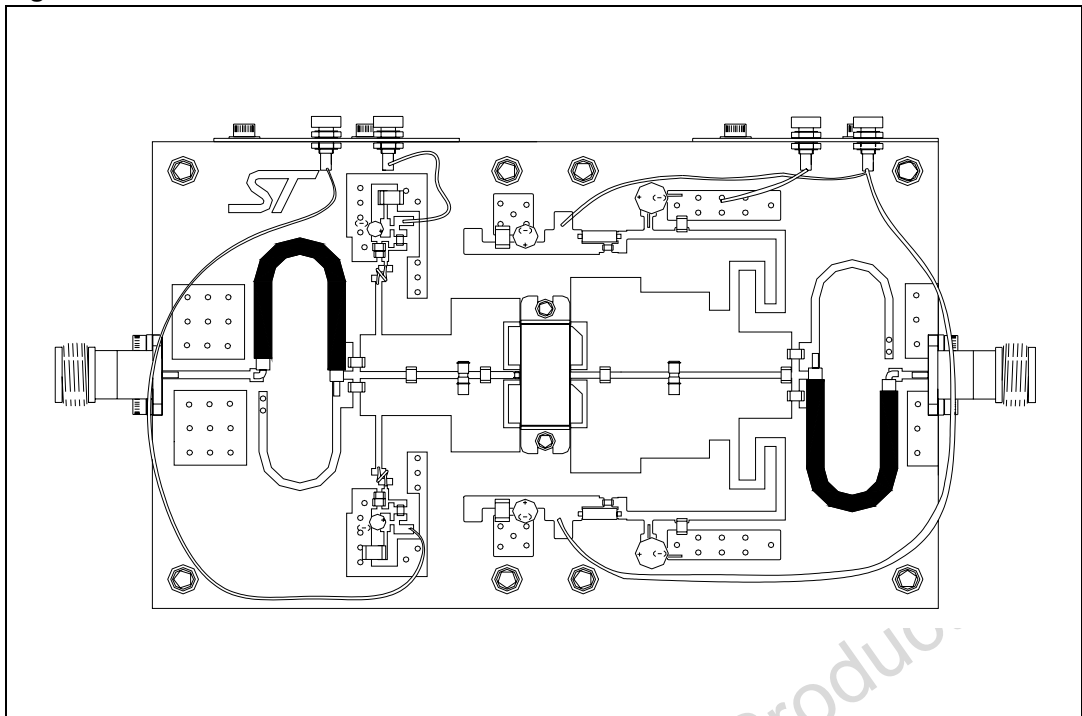
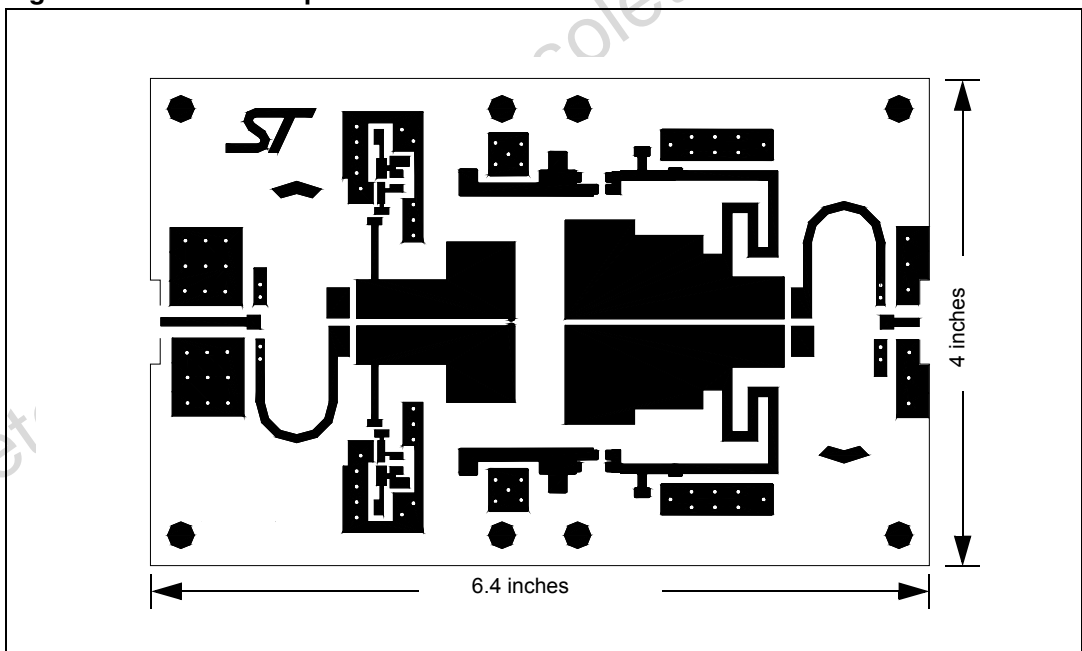

Figure 14. Test circuit photomaster



## 5 Package mechanical data

**Table 8. M252 (.400 x .860 4L BAL N/HERM W/FLG) mechanical data**

Dim.	mm.			Inch		
	Min	Typ	Max	Min	Typ	Max
A	8.13		8.64	.320		.340
B		10.80			.425	
C	3.00		3.30	.118		.130
D	9.65		9.91	.380		.390
E	2.16		2.92	.085		.115
F	21.97		22.23	.865		.875
G		27.94			1.100	
H	33.91		34.16	1.335		1.345
I	0.10		0.15	.004		.006
J	1.52		1.78	.060		.070
K	2.36		2.74	.093		.108
L	4.57		5.33	.180		.210
M	9.96		10.34	.392		.407
N	21.64		22.05	.852		.868

**Figure 15. Package dimensions**

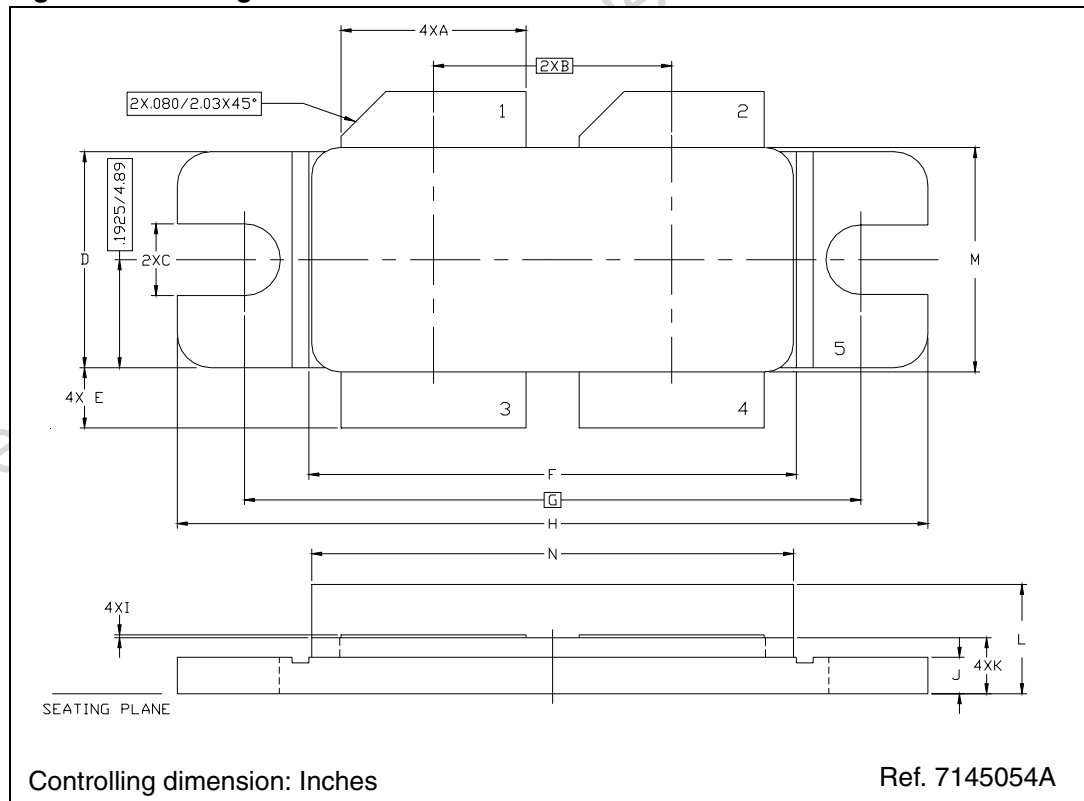

## 6 Revision history

**Table 9. Document revision history**

<b>Date</b>	<b>Revision</b>	<b>Changes</b>
12-Sep-2003	5	First Issue
23-Jul-2007	6	Document reformatted, added lead free info
24-Aug-2007	7	Cover page title updated

Obsolete Product(s) - Obsolete Product(s)

**Please Read Carefully:**

Information in this document is provided solely in connection with ST products. STMicroelectronics NV and its subsidiaries ("ST") reserve the right to make changes, corrections, modifications or improvements, to this document, and the products and services described herein at any time, without notice.

All ST products are sold pursuant to ST's terms and conditions of sale.

Purchasers are solely responsible for the choice, selection and use of the ST products and services described herein, and ST assumes no liability whatsoever relating to the choice, selection or use of the ST products and services described herein.

No license, express or implied, by estoppel or otherwise, to any intellectual property rights is granted under this document. If any part of this document refers to any third party products or services it shall not be deemed a license grant by ST for the use of such third party products or services, or any intellectual property contained therein or considered as a warranty covering the use in any manner whatsoever of such third party products or services or any intellectual property contained therein.

**UNLESS OTHERWISE SET FORTH IN ST'S TERMS AND CONDITIONS OF SALE ST DISCLAIMS ANY EXPRESS OR IMPLIED WARRANTY WITH RESPECT TO THE USE AND/OR SALE OF ST PRODUCTS INCLUDING WITHOUT LIMITATION IMPLIED WARRANTIES OF MERCHANTABILITY, FITNESS FOR A PARTICULAR PURPOSE (AND THEIR EQUIVALENTS UNDER THE LAWS OF ANY JURISDICTION), OR INFRINGEMENT OF ANY PATENT, COPYRIGHT OR OTHER INTELLECTUAL PROPERTY RIGHT.**

**UNLESS EXPRESSLY APPROVED IN WRITING BY AN AUTHORIZED ST REPRESENTATIVE, ST PRODUCTS ARE NOT RECOMMENDED, AUTHORIZED OR WARRANTED FOR USE IN MILITARY, AIR CRAFT, SPACE, LIFE SAVING, OR LIFE SUSTAINING APPLICATIONS, NOR IN PRODUCTS OR SYSTEMS WHERE FAILURE OR MALFUNCTION MAY RESULT IN PERSONAL INJURY, DEATH, OR SEVERE PROPERTY OR ENVIRONMENTAL DAMAGE. ST PRODUCTS WHICH ARE NOT SPECIFIED AS "AUTOMOTIVE GRADE" MAY ONLY BE USED IN AUTOMOTIVE APPLICATIONS AT USER'S OWN RISK.**

Resale of ST products with provisions different from the statements and/or technical features set forth in this document shall immediately void any warranty granted by ST for the ST product or service described herein and shall not create or extend in any manner whatsoever, any liability of ST.

ST and the ST logo are trademarks or registered trademarks of ST in various countries.

Information in this document supersedes and replaces all information previously supplied.

The ST logo is a registered trademark of STMicroelectronics. All other names are the property of their respective owners.

© 2007 STMicroelectronics - All rights reserved

STMicroelectronics group of companies

Australia - Belgium - Brazil - Canada - China - Czech Republic - Finland - France - Germany - Hong Kong - India - Israel - Italy - Japan - Malaysia - Malta - Morocco - Singapore - Spain - Sweden - Switzerland - United Kingdom - United States of America

[www.st.com](http://www.st.com)